

**I
N
H
A
L
T
S
V
E
R
Z
E
I
C
H
N
I
S**

**L
I
S
T
O
F
C
O
N
T
E
N
T
S**

Allgemeines General	0
Flachleisten Flat strips	1
Hohlkammerleisten Cavity strips	2
Einfassprofile Edge profiles	3
Deckleisten Cover strips	4
Winkel Angles	5
Glassprossen selbstklebend self-adhesive Georgian bars	6
Sohlbankanschlüsse sill connections	7
Rolladenführung u. Zubehör Shutter guides	8
Tür / Verbundelemente composite elements	9
Verkleidungs- u. Sonderprofile Special and panel sections	10
Fensterzubehör Windows Accessories	11
Dachprofile Roof panels	12
Merkblätter u. AGB Fact sheets and Terms & Conditions	13
Dekor-Übersicht List of colours	14

Übersicht Rolladenführung

Overview Shutter guides

8/2

Doppelrolladenführung

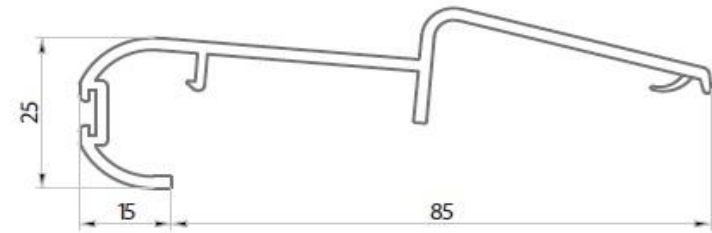
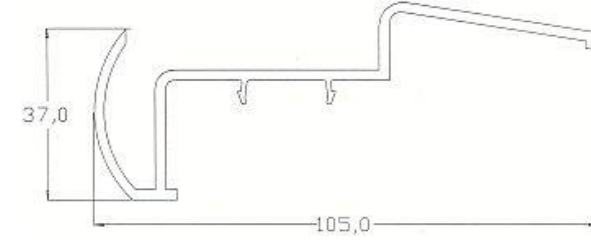
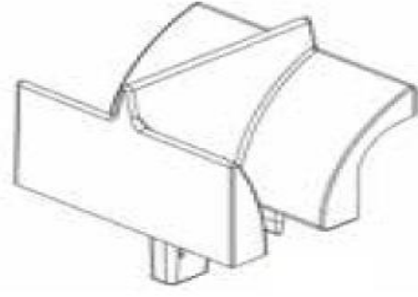
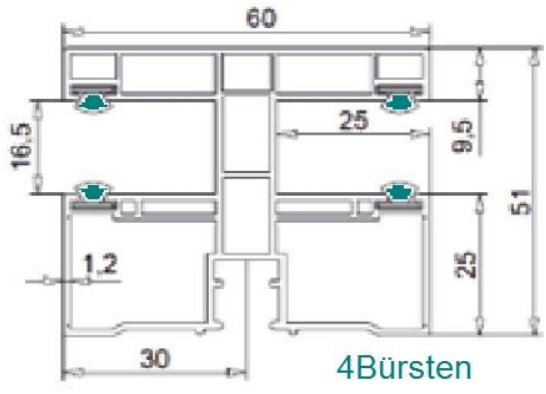

8/3

Rolladenführung

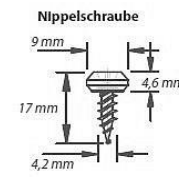
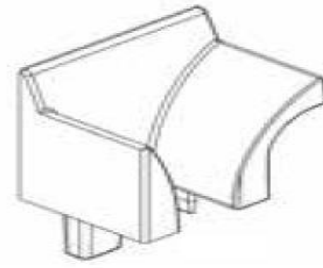
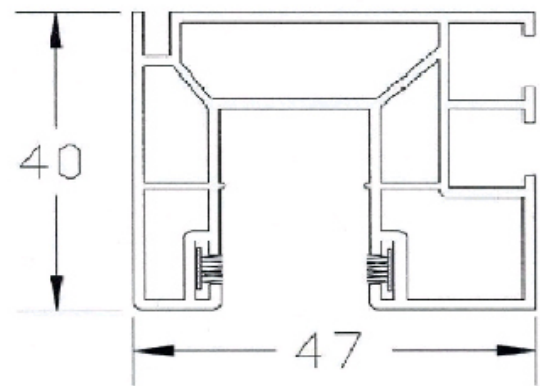
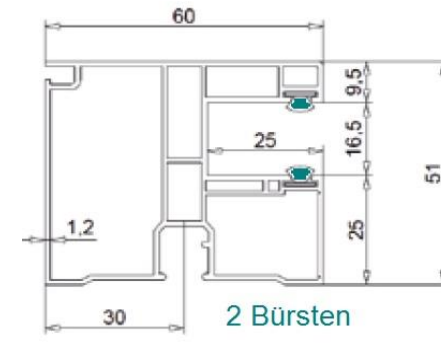

8/4

Kastenaufnahme

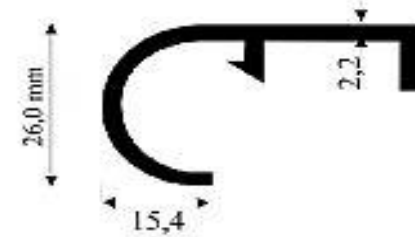
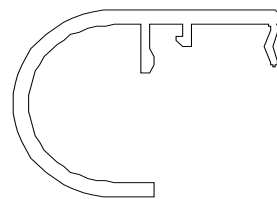
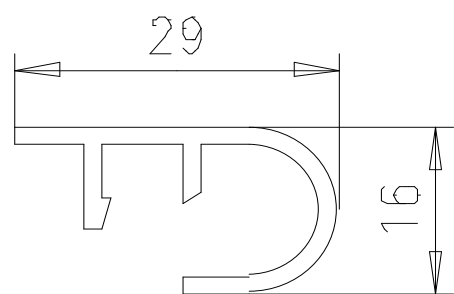
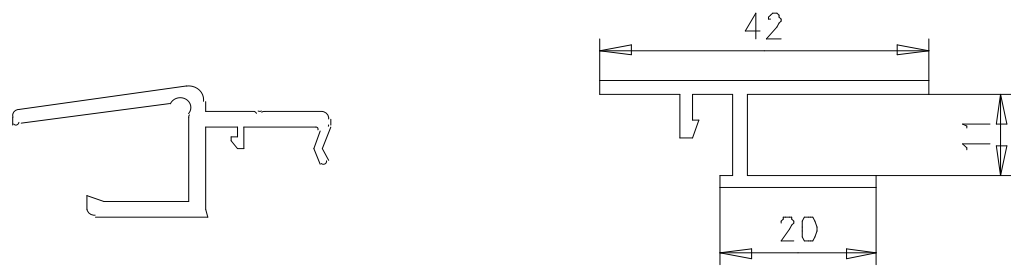

Rolladenführung

Shutter guides

Doppelrolladenführung

Double guides

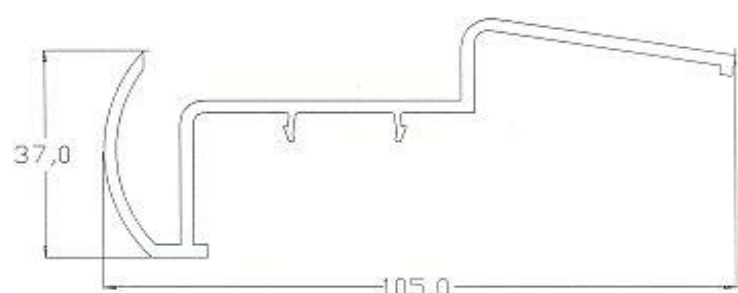

880459

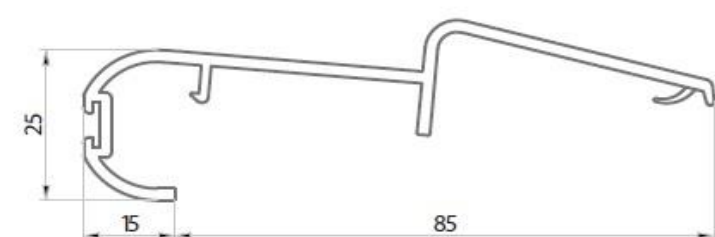

880466

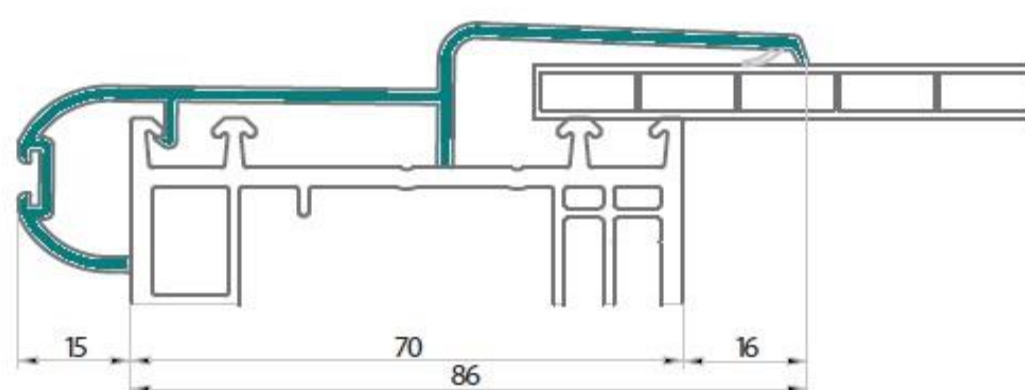

431298

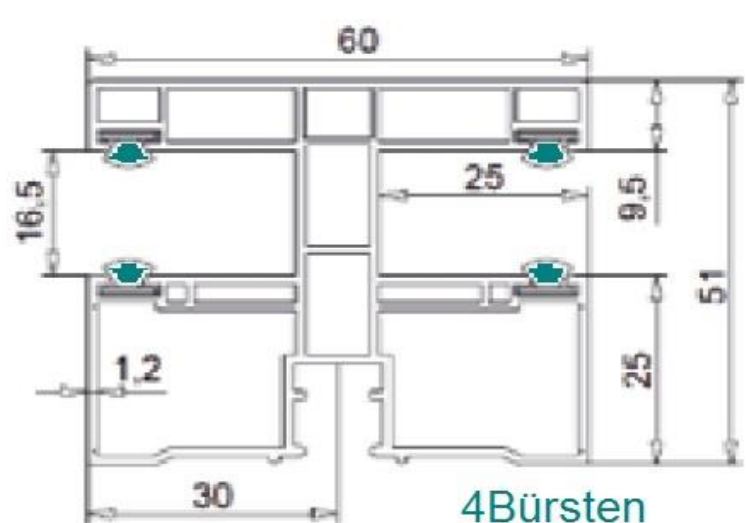
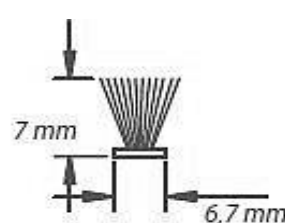

880938

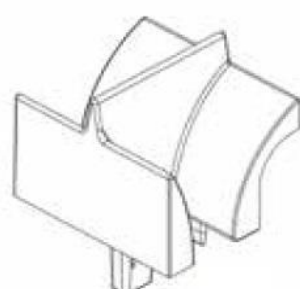

340918

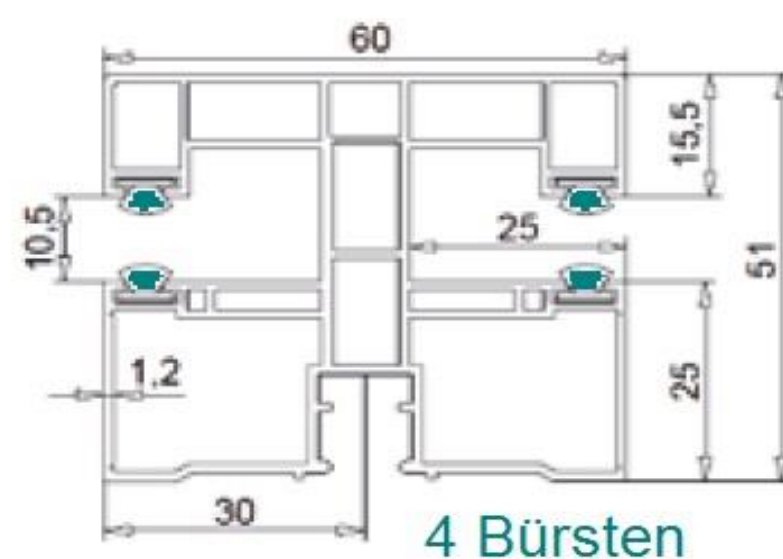

880937

Art. - Nr.	Rolladenführung	Packung /lfm	Ausführung	Lieferung	€/100 lfm
Cat. - No.	Shutter guides	Package/mtr/pcs	Execution	Delivery	€/100 lfm
880938	60 x 51 / 16,5 mm EB-grau maxi	36 36	○ ● Bürste D	☎ ☎	1.117,26 1.801,89
880937	60 x 51 / 10,5 mm EB-grau mini	36 36	○ ● Bürste D	☎ ☎	1.117,23 1.801,89
340918	Einlauftrichter	100 St	○ ● weiß braun	☎ ☎	285,31 285,31
880466	KA/AR 85 mm	60	○	☎	469,13
880459	KA/AR 105 x 37	60	○	☎	483,88
431298	Bürste / Brush 8 mm	200	●	☎	50,79

EB = eingezogene Bürsten

Rolladenführung

Shutter guides

mit Zubehör

with accessories

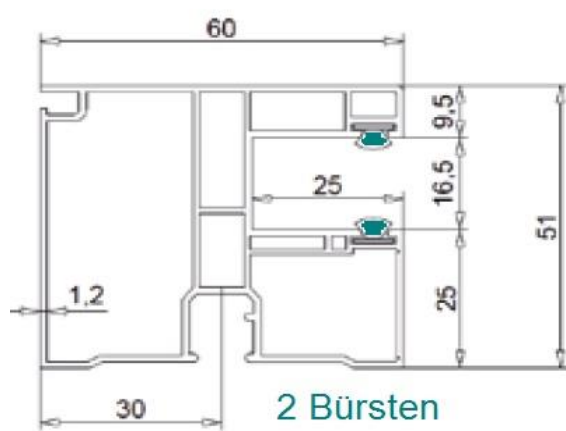

880999



880998
maxi Einfach



880997
maxi Revision Aussen

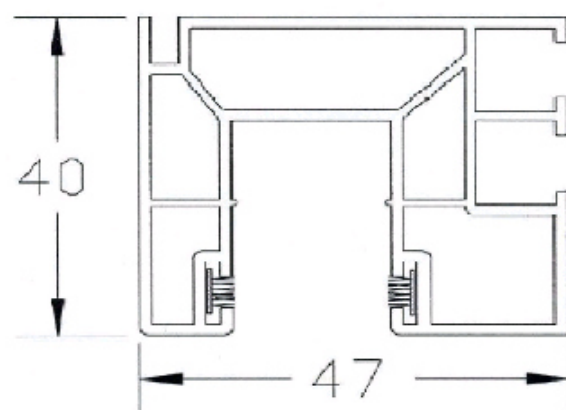

880299

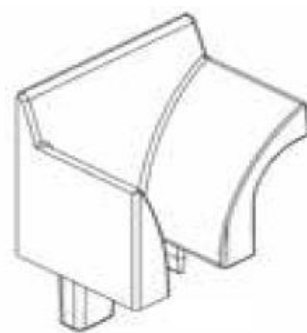

347777



880996

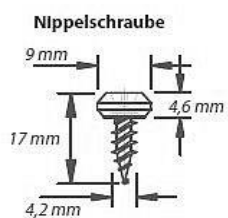

430603

Art. - Nr.	Rolladenführung	Packung /lfm	Ausführung	Lieferung	€/100 lfm
Cat. - No.	Shutter guides	Package/mtr.	Execution	Delivery	€/100 lfm
880999	60 x 51 / 16,5 mit EB(grau) maxi Einfach	36 30	○ D	☎ ☎	601,92 1.143,65
880998	35 x 51 / 16,5 mit EB(grau) maxi Einfach	36 30	○ D	☎ ☎	559,55 998,97
880996	60 x 51 / 10,5 mit EB(grau) mini Einfach	36 30	○ D	☎ ☎	616,93 1.164,59
880997	60 x 86 / 16,5 mit EB(grau) maxi Revision Aussen	36 30	○ D	☎ ☎	1.575,07 2.711,19
880299	40 x 47 / 17,5 mm EB	36	○	☎	495,42
O97777	Trichter / Funnel für 996	50 Paar / pairs	○	☎	121,54
347771	Trichter für 880299	100 Paar / pairs	○	☎	99,08
430603	Schraubnippel	1000 St/off		☎	14,84

EB = eingezogene Bürste

Rolladenführung

Shutter guides

Kastenaufnahmen 8 / 11 mm

Box holders 8 / 11 mm

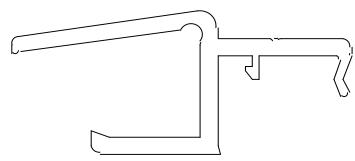

880443

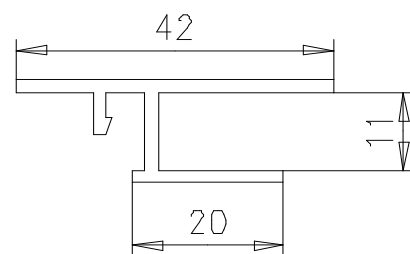

880430-880439

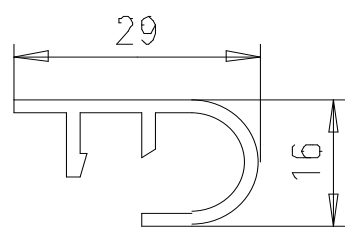

880431-880433-880438

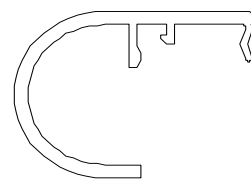

880442

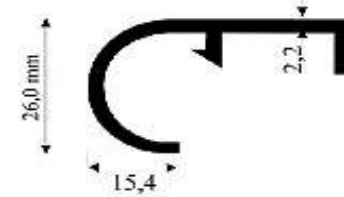

880469 /464

Art. - Nr.	Kastenaufnahme	Packung /lfm	Ausführung	Lieferung	€/100 lfm
Cat. - No.	Box holders	Package/mtr.	Execution	Delivery	€/100 lfm
880430	42 x 11 mm	60	○	☎	226,69
880439	42 x 11 mm	60	○	☎	218,58
880443	42 x 11 mm	60	○	☎	302,03
880431	29 x 16	60	○ ●	☎	154,47
880433	29 x 16	60	○ ●	☎	154,47
880438	29 x 16	60	○	☎	160,29
880442	33 x 25	60	○	☎	222,77
880469	43 x 26	60	○ ○	☎	171,94
880464	43 x 26	60	○ ○	☎	171,94

rastend für System	Artikel
Veka	880430 880431
Trocal	880430 880469
Rehau	880430 880431
Gealan	880439 880438
Kömmerling	880469 880438 880439
Aluplast	880430
Schüco	880430 880433
Brüggmann	880443
Thyssen	880464